

**Cisco Unified IP Phone Guide 7905G/7912G, 7906G/7911G,  
7940G/7960G, 7941G/7961G (SCCP)  
Cisco Unified Communications Manager Express**

- 1** Overview
- 2** Operating Your Phone
- 3** Phone Features and Functions List



# 1 Overview

This guide provides phone, soft key, and features descriptions for the following Cisco Unified IP Phone models:

- 7905G/7912G
- 7906G/7911G
- 7940G/7960G
- 7941G/7961G



## Cisco Unified IP Phone 7905G/7912G and 7906G/7911G



### Physical Layout

The Cisco Unified IP phones 7905/7912 and 7906/7911 phones are single-line phones. The 7906/7911 phones provide a higher resolution display than the 7905/7912 phones, and are similar in operation.



121276

	Name	Description
1	Cisco IP phone model type	Shows the Cisco IP phone model number.
2	LCD screen	Displays information such as line/call status, phone number, and soft key tabs.
3	Soft keys	Engages the functions displayed on the corresponding LCD tabs.
4	Navigation button 	Scrolls through text and selects features that are displayed on the LCD screen. Provides shortcut access to the Speed Dial menu when the phone is idle.
5	Menu button 	Provides access to phone services.

	Name	Description
6	Hold button 	Places an active call on hold. Resumes a held call.
7	Keypad	Functions like a traditional telephone keypad.
8	Volume button 	Increases or decreases handset volume and on-hook ring volume.
9	Handset with indicator light	Functions like a traditional handset.

## Connecting Your Phone

This section shows how to use the connectors on your Cisco IP phone.

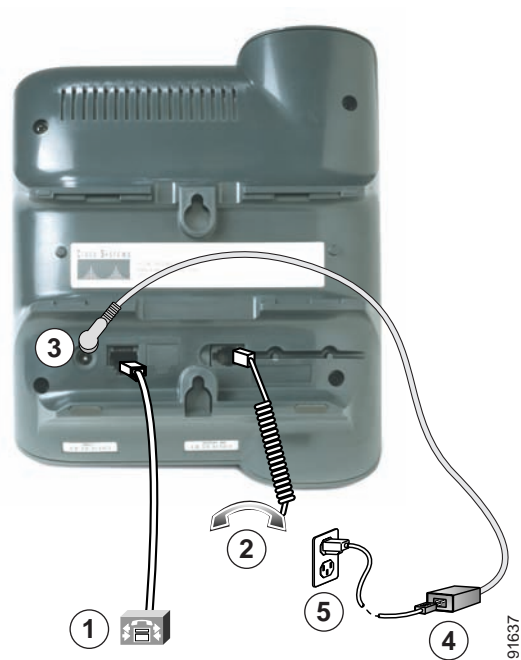

1	Network port (10BASE-T)	4	Cisco power supply (optional)
2	Handset port	5	Power cable with wall socket plug
3	DC adapter port (DC48V)		

## Adjusting the Handset Rest

When you connect your phone, you can adjust the handset rest so that the receiver will not slip out of the cradle. Use the following method to adjust the handset:

1. Set the handset aside and pull the square plastic tab from the handset rest.
2. Rotate the tab 180 degrees.
3. Slide the tab back into the handset rest. An extension protrudes from the top of the rotated tab. Return the handset to the handset rest.

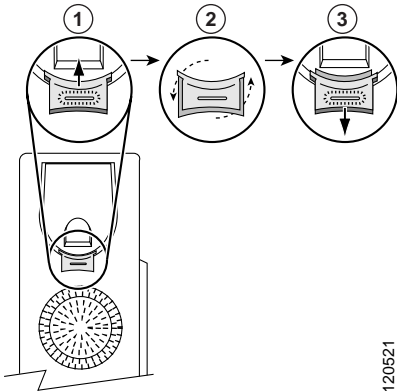











## Cisco Unified IP Phone 7960G/7940G and 7961G/7941G

The Cisco Unified IP phones 7940/7960 and 7941/7961 are multiline phones. The 7940 and 7941 have two lines; the 7960 and 7961 have 4 lines. The 7941/7961 phone provides a higher resolution display than the 7940/7960 phones, and are similar in operation.

### Physical Layout



	Name	Description
1	Cisco IP phone model type	Shows the Cisco IP phone model number.
2	LCD screen	Displays information such as line/call status, phone number, and soft key tabs.

	Name	Description
3	Line or speed-dial button 	Opens a new line, speed-dials a phone number, or ends a call. The Cisco Unified IP Phone 7940G has two lines, and the Cisco Unified IP Phone 7960G has six lines.
4	Footstand adjustment	Allows you to adjust the angle of the phone base.
5	Directories button 	Provides access to phone directories.
6	Question “?” button 	Not in use.
7	Settings button 	Provides access to phone settings such as display contrast and ring type.
8	Speaker button 	Toggles the speaker on and off.
9	Mute button 	Toggles mute on and off.
10	Headset button 	Toggles the headset on and off.
11	Volume button 	Increases or decreases handset, headset, ringer, or speakerphone volume.
12	Services button 	Provides access to phone services.
13	Messages button 	Provides access to a message system.
14	Navigation button 	Scrolls through text and selects features that are displayed on the LCD screen.
15	Keypad	Functions like a traditional telephone keypad.
16	Soft keys buttons	Engages the functions displayed on the corresponding LCD tabs.
17	Handset with indicator light	Functions like a traditional handset and provides message waiting indicator light and message-waiting (stutter) tone.

## Connecting Your Phone

This section show how to use the connectors on your Cisco IP phone.

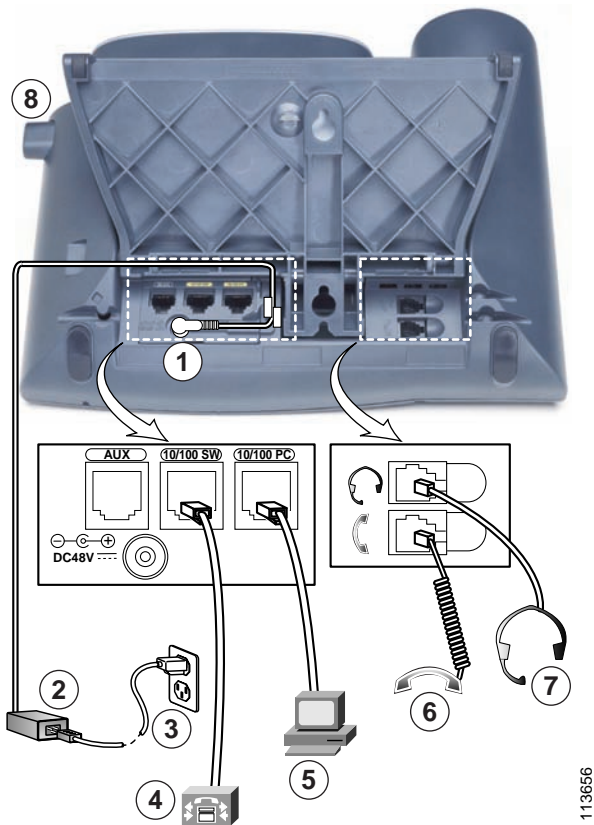

113656

1	DC adapter port (DC48V) for phones not provided with inline power	5	Access port (10/100 PC) for connecting your phone to your computer
2	AC-to-DC power supply	6	Handset port
3	AC power cord	7	Headset port
4	Network port (10/100 SW) for connecting to the network	8	Footstand button

## Adjusting the Handset Rest

When you connect your phone, you can adjust the handset rest so that the receiver will not slip out of the cradle. Use the following method to adjust the handset:

1. Set the handset aside and pull the square plastic tab from the handset rest.
2. Rotate the tab 180 degrees.
3. Slide the tab back into the handset rest. An extension protrudes from the top of the rotated tab. Return the handset to the handset rest.

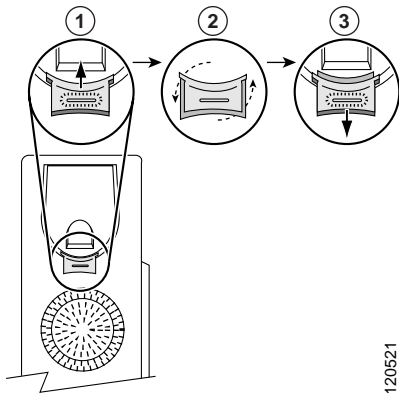

## Soft Key Descriptions

Your Cisco Unified IP phone is equipped with soft keys for call features and options. soft keys are displayed along the bottom of the LCD screen and are engaged using the corresponding buttons. Soft keys can change according to the state of the phone.

Following is a comprehensive list of soft keys offered on these Cisco Unified IP Phones. Functions depend on your system configuration.

Soft Key	Description
<< or >>	Navigates to edit characters. Use the backspace soft key to erase digits that were entered incorrectly.
Accept	Accepts the current edits. For instance, adding an entry to your personal directory.
Acct	Consult your administrator on the use of this soft key.
Add	Adds an entry to the personal directory.
Alpha	Toggles character input mode from numeric to alphanumeric.
Answer	Answers an incoming call.
BlndXfr	Redirects the call without allowing you to speak to the transfer recipient (known as a blind transfer).
Callback	Notifies callers that the called line is free.
Cancel	Cancels the last selection.
CFwdALL	Forwards all calls.
Clear	Clears directory history.
Confrn	Connects callers to a conference call.
DelAll	Deletes all entries in the personal directory.
Delete	Deletes selected item.
Dial	Dials the displayed number.
Directories	Provides access to phone directories.
DND	Enables and disables the Do-Not-Disturb feature.
Down	Decreases the LCD screen contrast.

Soft Key	Description (continued)
Edit	Selects a number and activates the cursor for editing.
EditDial	Selects a number and activates the cursor for editing.
EndCall	Ends the current call.
Exit	Exits from the current selection or screen.
Flash	Provides hookflash functionality for three-way calling and call waiting services provided by the PSTN or Centrex service.
GPickUp	Selectively picks up calls to a phone number that is a member of a pickup group.
Hold	Places an active call on hold. Resumes a held call.
Login	Provides PIN-controlled access to restricted phone features. Contact your system administrator for additional instructions.
Message	Dials the local voice-mail system.
Monitor	Enables the user to switch from the handset to the speaker to listen to a call hands-free.
Monoff	Enables the user to switch from the speaker to the handset and continue talking on the call.
more	Scrolls through additional soft key options (for example, use the more soft key to locate the Number soft key).
Mute	Toggles muting on and off.
NewCall	Opens a new line on the speakerphone to place a call.
Number	Toggles character input mode from alphanumeric to numeric.
Ok	Confirms the selection.
Park	Forwards calls to a location from which the call can be retrieved by anyone in the system.
PickUp	Selectively picks up calls to another extension.
Play	Plays the ring sound sample.
Redial	Redials the last number dialed.
Reorder	Reorder the entries in the Personal Directory.
Restore	Consult your system administrator on the use of this soft key.
Resume	Returns to an active call.
Save	Saves the last change.
Search	Initiates a search in the local directory.
Select	Selects the highlighted option.
Settings	Provides access to phone settings such as display contrast, ring volume, and ring type.
Trnsfer	Transfers selected calls to an alternate number.
Up	Increases the LCD screen contrast.
URL	Enter alphanumeric characters for call forwarding.

## 2 Operating Your Phone

This section describes how to operate your Cisco Unified IP phone. Because there are differences in phone and site configuration, not all features and procedures described here may apply to your phone. Consult your system administrator for more information. This section includes:

- [Basic: Place a Call, page 9](#)
- [Speakerphone: Place a Call, page 10](#)
- [Headset: Place a Call, page 10](#)
- [Answer a Call, page 10](#)
- [End a Call, page 10](#)
- [Redial a Number, page 10](#)
- [Hold a Call, page 10](#)
- [Mute a Call, page 11](#)
- [Manage Call Waiting, page 11](#)
- [Retrieve Voice-Mail Messages, page 11](#)
- [Call-Blocking \(Toll Bar\) Override, page 11](#)
- [Transfer a Call, page 12](#)
- [Forward All Calls, page 12](#)
- [Conference Calls, page 12](#)
- [Place a Call from Your Local Directory, page 14](#)
- [Program Personal Speed-Dial Buttons, page 15](#)
- [Place a Call from Your System Speed-Dial Directory, page 15](#)
- [View Call History, page 15](#)
- [Place a Call from Call History, page 15](#)
- [Clear Call History, page 16](#)
- [Use Audio Paging, page 16](#)
- [Use the Intercom Feature, page 16](#)
- [Activate Do Not Disturb, page 17](#)



---

**Note** In the following procedures, you may be required to enter information using the keypad. Press the backspace (<<) soft key to erase digits that were entered incorrectly.

---

### Basic: Place a Call

To place a call, use one of the following methods:

- Lift the handset and dial the number.
- Dial the number and then lift the handset.
- Press the line button for your extension, dial the number, and then lift the handset.
- Press any available button, dial the number, and then lift the handset.
- Press the New Call soft key, dial the number, and then lift the handset.
- Press a speed-dial button and then lift the handset.
- If you have selected a number from a directory, press the Dial soft key, and then lift the handset.

## Speakerphone: Place a Call

To place a call using the speakerphone, use one of the following methods:

- Press the speakerphone button and perform the steps for placing a basic call, and do not lift the handset.
- Perform the steps for placing a basic call and do not lift the handset.

To switch to handset operation, just lift the handset.

## Headset: Place a Call

To place a call using a headset, press the headset button, then perform the steps for placing a basic call, and do not lift the handset.

To switch to handset operation, just lift the handset.

## Answer a Call

To answer a call, use one of the following methods:

- Lift the handset.
- If you are using a headset, press the Headset button. If necessary, press the line button to select between incoming calls.
- To use the speakerphone, press the Answer soft key or the Speaker button.

## End a Call

To end a call, use one of the following methods:

- Hang up the handset.
- If you are using a headset, press the Headset button or the EndCall soft key.
- If you are using the speakerphone, press the Speaker button or the EndCall soft key.

## Redial a Number

To redial the most recently dialed number, use one of the following methods:

- Lift the handset and press the Redial soft key.
- Press the Redial soft key to dial using the speakerphone.

## Hold a Call

To place a call on hold while on the call, press the Hold soft key.

To retrieve a held call, press the Resume soft key.

If multiple calls are on hold, use the Navigation button to select the desired call before you press Resume.

If multiple calls on multiple lines are on hold, press the line button for the line that you want to pick up. The active call on the other line is automatically put on hold.



---

**Note** Because the hold feature can generate music or beeps, avoid using hold when dialed into a remote conference system. Simple three-party conferences that are created locally on your phone can safely be placed on hold without introducing music or beeps into the conference.

---

## Mute a Call

To mute a call, press the Mute button. The Mute button lights, indicating that the other party cannot hear you.

To deactivate the mute function, use one of the following methods:

- Press the Mute button again.
- Lift the handset if you are using mute with the speakerphone.



---

**Note** The Mute feature does not generate music or beeps.

---

## Manage Call Waiting

If you are on a call when a second call comes in, you hear a call-waiting tone or see a flashing indicator light on the handset rest, depending on the configuration of your phone.

To answer the new call on the same line, use the following method:

1. Use the Navigation button to select the call.
2. Press the Answer soft key to answer the call. The call on the other line is automatically put on hold.

To return to the original call, use the following method:

1. Use the Navigation button to reselect the call.
2. Press the Resume soft key to reconnect to the call.

For calls on a separate line, press the Line button for the incoming call. The call on the other line is automatically put on hold.

To return to the original call, press the Line button associated with the original call.

## Retrieve Voice-Mail Messages

To access voice messages, use the following method:

1. Select an available Cisco Unified IP phone line by lifting the handset, by pressing the speakerphone button, or by pressing a line button. Listen for the dial tone.
2. Press the Messages button, and follow the voice instructions.



---

**Note** When you have one or more new messages, if you have the message-waiting indicator (MWI) configured, the light on your handset is lit.

---

## Call-Blocking (Toll Bar) Override

Call blocking prevents unauthorized use of phones. It is implemented by matching a pattern of specified digits during a specified time and day of week or date. The call-blocking override feature allows individual phone users to override the call blocking that has been defined.

To place calls when call-blocking is enabled, use the following method:

1. Press the Login soft key on the Cisco IP phone.
2. Enter the PIN that is associated with the phone.



---

**Note** Contact your system administrator for your personal identification number (PIN).

---

## Transfer a Call

To transfer a selected call to another number, use one of the following methods:

- **Blind transfer**—Immediately redirects the call without allowing you to speak to the transfer recipient (the person to whom you are transferring the call).
- **Consult transfer**—Redirects the call after first allowing you to speak to the transfer recipient.

To transfer a call, use the following method:

1. During a call, press the **Trnsfr** soft key. The call is placed on hold.
2. Dial the number to which you want to transfer the call.
3. To make a blind transfer:
  - Hang up the handset or press the **BlndXfr** soft key after you hear line ringing.
4. To make a consult transfer:
  - Wait for the call to be answered. Speak to the transfer recipient. Then press the **Trnsfr** button or hang up the handset.
  - If the transfer fails, press the **Resume** soft key to return to the original call.
5. To cancel your consult call-transfer attempt:
  - Press the **EndCall** soft key.
6. To reconnect to the original caller:
  - Press the **Resume** soft key.

## Forward All Calls

To forward all incoming calls to another number, use the following method:

1. Press the **CFwdALL** soft key.
2. Dial the number to which you want to forward all your calls. Dial the number exactly as you would if you were placing a call to that number. Remember to include locally required prefix numbers. The phone display is updated to show that calls are to be forwarded.
3. Press the **Accept** soft key.



---

**Note** To forward calls to voice mail, manually enter the voice-mail number, or use the soft key and button sequence of **CFwdALL** soft key plus the **Messages** button, followed by the **EndCall** soft key.

To forward calls to a speed-dial number, use the soft key and button sequence of the **CFwdALL** soft key plus a speed-dial button, followed by the **EndCall** soft key.

---

4. To cancel call forwarding, press the **Cancel** soft key.

## Conference Calls

Your Cisco Unified IP Phone provides three types of conference calls: Standard, Meet-Me, and Ad Hoc conference calls.

### Standard Conference Calls

A standard conference call involves three parties.

You can create a standard conference in different ways, depending on your needs and the soft keys available on your phone:

- **Confrn**—Use this soft key to establish a standard conference by calling each participant. Standard conference calling is a default feature available on most phones.
- **Join**—Use this soft key to establish a standard conference by joining several calls already on one line.

- **cBarge**—Use this soft key to add yourself to an existing call on a shared line and to turn the call into a standard conference call. This feature is available only on phones that use shared lines.

### Meet-Me Conference Calls

A Meet-Me conference call involves up to eight parties.

You can create a Meet-Me conference by calling the Meet-Me phone number at a specified time.

### Ad Hoc Conference Calls

An Ad Hoc conference call involves up to 32 parties.

You can create an Ad Hoc conference call the same way you do a standard conference call.

## Place a Conference Call

To place a three-party conference call, use the following method:

1. During a call, press the more soft key and then the Confrn soft key to open a new line and put the first party on hold.
2. Place a call to another number.
3. When the call connects, press the Confrn soft key again to add the new party to the existing call with the first party.

To establish a conference call between two callers to a Cisco Unified IP phone, one active and the other on hold, press the Confrn soft key.

To establish a conference call between two callers already present on a Cisco Unified IP phone, using separate line buttons, one active and the other on hold, use the following method:

1. Press the Confrn soft key.
2. Press the Line button of the call you want to add to the three-party conference.

## End a Conference Call

To end the conference call, use one of the following methods:

- Hang up the handset.
- Press the EndCall soft key.

## Alternate Methods to End a Conference Call

Call initiators may use one of the following methods (functions vary according to your system configuration):

- To end the conference and remain connected to the most recent call, press the Confrn soft key. The older call is placed on hold.
- To disconnect from the conference, hang up the handset. The other parties remain on the conference call.

## Meet-Me Conference Call

Meet-Me conferencing allows you to start or join a conference by dialing the conference number and supports up to 32 parties.

To start a Meet-Me conference, use the following method:

1. Obtain a Meet-Me phone number from your system administrator.
2. Distribute the number to participants.
3. Obtain a dial tone, then press the the more > MeetMe soft keys.
4. Dial the Meet-Me conference number. Participants can now join the conference by dialing in.



---

**Note** You hear a busy tone if you call the conference before the initiator has joined. If this happens, try your call again.

---

To end a Meet-Me conference, all participants must hang up. The conference does not automatically end when the conference initiator disconnects.

## Ad Hoc Conference Call

Ad hoc conferences, which support up to eight parties, are created when one party calls another, then either party decides to add another party to the call. This is the default behavior. Your system can be configured so that only the conference creator can add parties to the conference.

The default is that the conference is maintained as long as three parties remain in the conference. Any party can hang up and the conference is maintained. Your system can be configured so that the conference drops when the creator hangs up. Your system can also be configured so that the conference drops when the last local party hangs up.

### Start a Conference Call

To add new participants to an existing conference, use the following method:

1. From a connected call, press Confrn. (You may need to press the more soft key to see Confrn.)
2. Enter the participant's phone number.
3. Wait for the call to connect.
4. Press Confrn again to add the participant to your call.
5. Repeat to add additional participants.

### View a List of Participants

To view a list of conference participants, use the following method:

1. Highlight an active conference.
2. Press ConfList. Participants are listed in the order in which they join the conference with the most recent additions at the top.
3. To get an updated list of participants, while viewing the conference list, press Update.
4. To see who started the conference, while viewing the conference list, locate the person listed at the bottom of the list with an asterisk (\*) next to the name.
5. To drop the last party added to the conference, press RmLstC. You can remove participants only if you initiated the conference call.

### Remove Participants

To remove any conference participant, use the following method:

1. Highlight the participant's name.
2. Press Remove. You can remove participants only if you initiated the conference.
3. To end your participation in a conference, hang up or press EndCall.

## Place a Call from Your Local Directory

To access the local phone directory established by the system administrator, use the following method:

1. Press the Directories button.
2. Press the Navigation Up or Down button or press 4 to select the Local Directory.
3. Press the Navigation Up or Down button to select the Last, First, or Number field search option.
4. Using the keypad, enter the last name or first name for the entry.

When entering letters, select the appropriate number key of the letter you want, and press that key a number of times that equals the position of the target letter. For example, to enter a B, press the 2 key two times, and to enter a C, press the 2 key three times. Use the backspace (<<) soft key to make corrections while entering data.

5. Press the Search soft key to find your selection.
6. If your search results in multiple listings, use the Navigation Up or Down button to select the correct number.
7. Press the Dial soft key to dial the selected number.

## Program Personal Speed-Dial Buttons

After an administrator has defined one or more speed-dial instances for a Cisco Unified IP phone, you can reprogram numbers that are not locked or program numbers into an instance that has an empty dial string.

To program personal speed-dial buttons, use the following method:

1. Select an available phone line by lifting the handset, by pressing the NewCall soft key, or by pressing a line button. Listen for the dial tone.
2. Press the pound key (#).
3. Press the speed-dial button that you want to program. A short beep confirms that you are starting to program this button.
4. Enter the speed-dial number. The digits appear on the phone display. When you are entering speed-dial numbers, use the backspace (<<) soft key to erase digits that were entered incorrectly.

To remove a speed-dial number without replacing it with a new one, press the pound key (#).

5. Press the same speed-dial button a second time to indicate that you have finished entering the speed-dial digits and to store the new speed-dial number.
6. Hang up the handset, or press a new speed-dial button and repeat the process.

## Place a Call from Your System Speed-Dial Directory

To place a call from your system speed-dial directory, use the following method:

1. Select an available IP phone line (off hook or NewCall) and get a dial tone.
2. Press the Directories button, or use the Navigation button to locate Directory and then press the Select soft key.
3. Use the Navigation button to scroll through the options. Use the Select soft key to select speed-dial options.
  - Press 5 for the Local Speed Dial.
  - Press 6 for the Personal Speed Dial. (Functions vary depending on your system configuration.)
4. Use the Navigation button to scroll through the speed-dial phone list.
5. To dial the selected phone number, press the Select soft key, or enter the entry number on the keypad.
6. Press the Exit soft key to return to the previous directory menu.

## View Call History

To view recent missed, received, or placed calls, use the following method:

1. Press the Directories button.
2. Use the Navigation button to scroll and select the desired call list.
3. Use one of the methods below to choose a call list:
  - Press the Select soft key.
  - Press 1 on the keypad for Missed Calls.
  - Press 2 on the keypad for Received Calls.
  - Press 3 on the keypad for Placed Calls.
4. Press the Exit soft key to return to the previous directory menu.

## Place a Call from Call History

To place a call to a number in the call history list, use the following method:

1. Use the Navigation button to scroll through the call history list.
2. Use the Select soft key to select a phone number. The digits appear on the phone display.
3. To dial the number as it appears on the phone display:

- Press the Dial soft key.

To edit the number on the phone display before dialing, use the following method:

1. Press the Edit soft key to place the cursor at the beginning of the number on the phone display.
2. Use the keypad to edit the digits as needed. Use the backspace (<<) soft key to erase incorrectly entered digits.
3. Press the Dial soft key to place the call.

## Clear Call History

To clear all numbers in the directory histories, press the Clear soft key.



---

**Note** The Clear soft key clears all call history lists. Selective clearing of call history lists is not supported.

---

## Use Audio Paging

Audio paging provides a one-way voice path to the phones that have been designated to receive paging. It does not have a press-to-answer option like the intercom feature.

To use the paging function for paging a group, use the following method:

1. Select an available phone line by lifting the handset. Listen for the dial tone.
2. Dial the designated paging group number.  
Each idle IP phone that has been configured with the paging number answers automatically in speakerphone mode, and the phone displays the caller ID.
3. When you finish speaking your message and hang up, the phones are returned to their idle states.

## Use the Intercom Feature

Cisco Unified Communications Manager Express supports intercom functionality for one-way and press-to-answer voice connections using a dedicated pair of intercoms on two phones that speed-dial each other.

To use the intercom feature, use the following method:

1. Press the Menu button.
2. Use the Navigation button to select Directories.
3. Use the Navigation button to select Speed Dial.
4. Select intercom Speed Dial.  
The called IP phone automatically answers the call in speakerphone mode with mute activated. A beep alerts the recipient to the incoming call.

To respond to an intercom call, press the Mute button, or lift the handset.

## Activate Do Not Disturb

For visual call alerting and information without audible ringing, use Do Not Disturb (DND). Calls receive normal call-forward-busy and no-answer treatment.

To activate DND, use the following method:

1. Press the more soft key to locate the DND soft key.
2. Press the DND soft key. A display text message indicates that the phone is in Do-Not-Disturb mode.



---

**Note** Pressing the DND soft key immediately forwards the call to the call-forward destination set on the phone. If the call-forward destination is not set, pressing the DND soft key disables the ringer.

---

To deactivate the Do-Not-Disturb feature, repeat Steps 1 and 2.

## Setting and Adjusting Your Cisco Unified IP Phone

### Adjust the Volume for the Current Call

To adjust the handset, speakerphone, or headset volume for the current call, use the following method:

1. During a call, press the Up or Down Volume button.
2. Press the Save soft key to apply the new volume level to future calls.

### Adjust the Ring Volume

To adjust the ring volume, press the Up or Down Volume button while the handset is in its cradle.

### Select the Ring Type

To change the ring type, use the following method:

1. Press the Settings button.
2. Press 2 for Ring Type, or use the Navigation button to select Ring Type and press the Select soft key.
3. Use the Navigation button to select the ring type. Press the Play soft key to hear samples.
4. Highlight the ring you want, and then press the Select soft key.
5. Use one of the following options:
  - Press the Ok soft key to select your setting, which returns you to the previous menu,
  - Press Cancel to exit to the previous menu without changing the setting.
  - Press the Back soft key to return to the main phone screen.

### Adjust the Display Contrast

To adjust the contrast in your LCD Display, use the following method:

1. Press the Settings button.
2. Press 1 for Contrast, or use the Select soft key.
3. Use the Down or Up soft key to change the contrast.
4. Use one of the following options:
  - Press the Ok soft key to select your contrast setting, which returns you to the main directory,
  - Press Cancel to exit to the previous menu without changing the setting.
  - Press the Back soft key to return to the main phone screen.

## 3 Phone Features and Functions List

The following list is an alphabetical list of features and functions for your IP phone.

- Activate Do Not Disturb, page 17
- Adjust the Display Contrast, page 17
- Adjust the Ring Volume, page 17
- Adjust the Volume for the Current Call, page 17
- Answer a Call, page 10
- Call-Blocking (Toll Bar) Override, page 11
- Clear Call History, page 16
- End a Call, page 10
- End a Conference Call, page 13
- Forward All Calls, page 12
- Hold a Call, page 10
- Manage Call Waiting, page 11
- Mute a Call, page 11
- Basic: Place a Call, page 9
- Headset: Place a Call, page 10
- Speakerphone: Place a Call, page 10
- Place a Call from Call History, page 15
- Place a Call from Your Local Directory, page 14
- Place a Call from Your System Speed-Dial Directory, page 15
- Place a Conference Call, page 13
- Program Personal Speed-Dial Buttons, page 15
- Redial a Number, page 10
- Retrieve Voice-Mail Messages, page 11
- Select the Ring Type, page 17
- Transfer a Call, page 12
- Use Audio Paging, page 16
- Use the Intercom Feature, page 16
- View Call History, page 15



## CISCO SYSTEMS



Corporate Headquarters  
Cisco Systems, Inc.  
170 West Tasman Drive  
San Jose, CA 95134-1706  
USA  
[www.cisco.com](http://www.cisco.com)  
Tel: 408 526-4000  
800 553-NETS (6387)  
Fax: 408 526-4100

European Headquarters  
Cisco Systems International BV  
Haarlerbergpark  
Haarlerbergweg 13-19  
1101 CH Amsterdam  
The Netherlands  
[www-europe.cisco.com](http://www-europe.cisco.com)  
Tel: 31 0 20 357 1000  
Fax: 31 0 20 357 1100

Americas Headquarters  
Cisco Systems, Inc.  
170 West Tasman Drive  
San Jose, CA 95134-1706  
USA  
[www.cisco.com](http://www.cisco.com)  
Tel: 408 526-7660  
Fax: 408 527-0883

Asia Pacific Headquarters  
Cisco Systems, Inc.  
168 Robinson Road  
#28-01 Capital Tower  
Singapore 068912  
[www.cisco.com](http://www.cisco.com)  
Tel: +65 6317 7777  
Fax: +65 6317 7799

Cisco Systems has more than 200 offices in the following countries. Addresses, phone numbers, and fax numbers are listed on the  
**Cisco Web site at [www.cisco.com/go/offices](http://www.cisco.com/go/offices)**

Argentina • Australia • Austria • Belgium • Brazil • Bulgaria • Canada • Chile • China PRC • Colombia • Costa Rica • Croatia • Cyprus • Czech Republic • Denmark  
Dubai, UAE • Finland • France • Germany • Greece • Hong Kong SAR • Hungary • India • Indonesia • Ireland • Israel • Italy • Japan • Korea • Luxembourg • Malaysia  
Mexico • The Netherlands • New Zealand • Norway • Peru • Philippines • Poland • Portugal • Puerto Rico • Romania • Russia • Saudi Arabia • Scotland • Singapore  
Slovakia • Slovenia • South Africa • Spain • Sweden • Switzerland • Taiwan • Thailand • Turkey • Ukraine • United Kingdom • United States • Venezuela • Vietnam  
Zimbabwe

CCVP, the Cisco logo, and the Cisco Square Bridge logo are trademarks of Cisco Systems, Inc.; Changing the Way We Work, Live, Play, and Learn is a service mark of Cisco Systems, Inc.; and Access Registrar, Alronet, BPX, Catalyst, CCDA, CCDP, CCIE, CCIP, CCNA, CCNP, CCSP, Cisco, the Cisco Certified Internetwork Expert logo, Cisco IOS, Cisco Press, Cisco Systems, Cisco Systems Capital, the Cisco Systems logo, Cisco Unity, Enterprise/Solver, EtherChannel, EtherFast, EtherSwitch, Fast Step, Follow Me Browsing, FormShare, GigaDrive, HomeLink, Internet Quotient, IOS, iPhone, IP/TV, IQ Expertise, the IQ logo, IQ Net Readiness Scorecard, iQuick Study, LightStream, Linksys, MeetingPlace, MGX, Networking Academy, Network Registrar, Packet, PIX, ProConnect, ScriptShare, SMARTnet, StackWise, The Fastest Way to Increase Your Internet Quotient, and TransPath are registered trademarks of Cisco Systems, Inc. and/or its affiliates in the United States and certain other countries.

All other trademarks mentioned in this document or Website are the property of their respective owners. The use of the word partner does not imply a partnership relationship between Cisco and any other company. (0705R)